



TRUE MANUFACTURING CO., INC.
U.S.A. FOODSERVICE DIVISION

2001 East Terra Lane • O'Fallon, Missouri 63366-4434 • (636)240-2400
Fax (636)272-2408 • Toll Free (800)325-6152 • Intl Fax# (001)636-272-7546
Parts Dept. (800)424-TRUE • Parts Dept. Fax# (636)272-9471 • www.truemfg.com

Project Name: _____

Location: _____

Item #: _____ Qty: _____

Model #: _____

A/A #

SIS #

Model:
GDM-47-HC-LD

Glass Door Merchandiser:

Slide Door Refrigerator with Hydrocarbon Refrigerant & LED Lighting



GDM-47-HC-LD

- ▶ The world's #1 manufacturer of glass door merchandisers.
- ▶ Factory engineered, self-contained, capillary tube system using environmentally friendly R290 hydro carbon refrigerant that has zero (0) ozone depletion potential (ODP), & three (3) global warming potential (GWP).
- ▶ High capacity, factory balanced, refrigeration system holds 33°F to 38°F (5°C to 3.3°C) for best food preservation in extreme conditions.
- ▶ Exterior - non-peel or chip black laminated vinyl; durable and permanent.
- ▶ Interior - attractive, NSF approved, white aluminum interior liner with stainless steel floor.
- ▶ Self closing doors. Counter-balanced weight system for smooth, even, positive closing.
- ▶ "Low-E", double pane thermal insulated glass door assemblies with mitered plastic channel frames. The latest in energy efficient technology.
- ▶ LED interior lighting provides more even lighting throughout the cabinet. Safety shielded.
- ▶ Entire cabinet structure is foamed-in-place using a high density, polyurethane insulation that has zero ozone depletion potential (ODP) and zero global warming potential (GWP).

Bottom mounted units feature

- ▶ "No stoop" lower shelf to maximize product visibility.
- ▶ Storage on top of cabinet.
- ▶ Easily accessible condenser coil for cleaning.

ROUGH-IN DATA

Specifications subject to change without notice.
Chart dimensions rounded up to the nearest 1/8" (millimeters rounded up to next whole number).

Model	Doors	Shelves	Cabinet Dimensions (inches) (mm)			HP	Voltage	Amps	NEMA Config.	Cord Length (total ft.) (total m)	Crated Weight (lbs.) (kg)
			W	D†	H						
GDM-47-HC-LD	2	8	54 1/8 1375	29 3/8 753	78 3/8 1998	1/2 N/A	115/60/1	8.5 N/A	5-15P	10 3.05	485 220

† Depth does not include 3/8" (10 mm) for door handles.



APPROVALS:

AVAILABLE AT:

5/20

Printed in U.S.A.

Model:
GDM-47-HC-LD

Glass Door Merchandiser:
Slide Door Refrigerator with Hydrocarbon Refrigerant & LED Lighting



STANDARD FEATURES

DESIGN

- True's commitment to using the highest quality materials and oversized refrigeration systems provides the user with colder product temperatures, and lower utility costs in an attractive merchandiser that brilliantly displays packaged food and beverages.

REFRIGERATION SYSTEM

- Factory engineered, self-contained, capillary tube system using environmentally friendly R290 hydrocarbon refrigerant that has zero (0) ozone depletion potential (ODP), & three (3) global warming potential (GWP).
- High capacity, factory balanced refrigeration system that maintains cabinet temperatures of 33°F to 38°F (.5°C to 3.3°C) for the best in food preservation.
- State of the art, electronically commutated evaporator and condenser fan motors. ECM motors operate at higher peak efficiencies and move a more consistent volume of air which produces less heat, reduces energy consumption and provides greater motor reliability.
- Bottom mounted condensing unit positioned for easy maintenance. "No stoop" lower shelf maximizes visibility by raising merchandised product to higher level.

CABINET CONSTRUCTION

- Exterior - non-peel or chip black laminated vinyl; durable and permanent.
- Interior - attractive, NSF approved, white aluminum liner with stainless steel floor.

- Insulation - entire cabinet structure is foamed-in-place using a high density, polyurethane insulation that has zero ozone depletion potential (ODP) and zero global warming potential (GWP).
- Welded, heavy duty steel frame rail, black powder coated for corrosion protection.
- Frame rail fitted with leg levelers.
- Illuminated exterior sign panel. Variety of sign options available.

DOORS

- "Low-E", double pane thermal insulated glass door assemblies with mitered plastic channel frames. The latest in energy efficient technology.
- Each door fitted with 12" (305 mm) long handle.
- Self closing doors. Counter-balanced weight system for smooth, even, positive closing.

SHELVING

- Eight (8) adjustable, heavy duty PVC coated wire shelves 24 7/16" L x 20 9/16" D (621 mm x 523 mm). Four (4) chrome plated shelf clips included per shelf.
- Shelf support pilasters made of same material as cabinet interior; shelves are adjustable on 1/2" (13 mm) increments.

LIGHTING

- LED interior lighting provides more even lighting throughout the cabinet. Safety shielded.

MODEL FEATURES

- Evaporator is epoxy coated to eliminate the potential of corrosion.
- See our website www.truemfg.com for latest color and sign offerings.

- Convenient clean-out drain built in cabinet floor.
- Listed under NSF/ANSI Standard 7 for the storage and/or display of packaged or bottled product.

ELECTRICAL

- Unit completely pre-wired at factory and ready for final connection to a 115/60/1 phase, 15 amp dedicated outlet. Cord and plug set included.



115/60/1
NEMA-5-15R

OPTIONAL FEATURES/ACCESSORIES

Upcharge and lead times may apply.

- White exterior.
- Stainless steel exterior.
- Black aluminum interior liner with black shelving.
- Stainless steel interior liner.
- 6" (153 mm) standard legs.
- 6" (153 mm) seismic/flanged legs.
- 2 1/2" (64 mm) diameter castors.
- 4" (102 mm) diameter castors.
- Red wine thermostat.
- White wine thermostat.
- Chocolate thermostat.
- Barrel lock (factory installed).
- Ratchet locks.
- Wine racks.
- Additional shelves.
- TrueFlex/TrueTrac gravity feed organizers.

PLAN VIEW

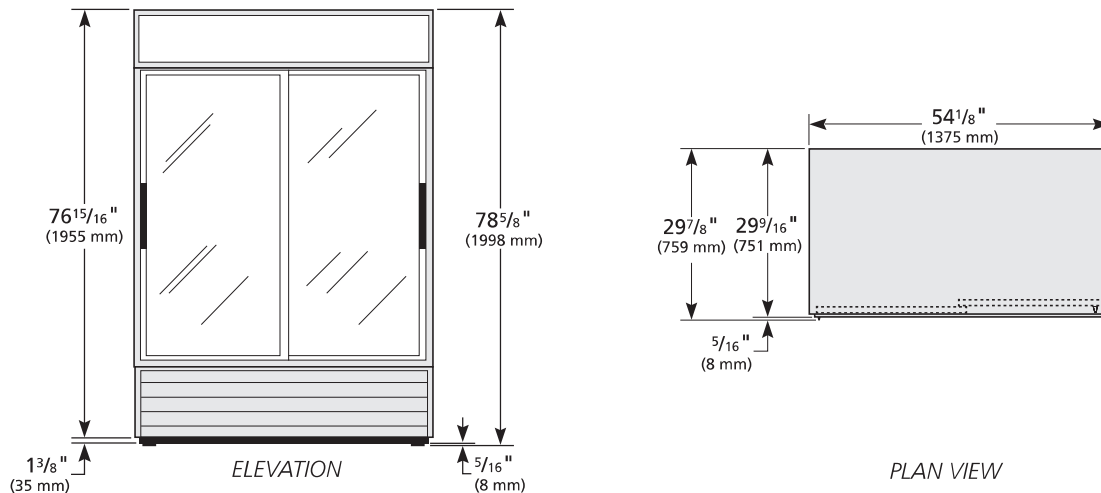

3 YEAR PARTS + LABOR
7 YEAR COMPRESSOR
WARRANTY
(U.S.A. only)

METRIC DIMENSIONS ROUNDED UP TO THE NEAREST WHOLE MILLIMETER
SPECIFICATIONS SUBJECT TO CHANGE WITHOUT NOTICE



Model	Elevation	Right	Plan	3D	Back
GDM-47-HC-LD	TFAY04E	TFAY07S	TFAY04P	TFAY043	

TRUE MANUFACTURING CO., INC.