



**TRUE MANUFACTURING CO., INC.**  
**U.S.A. FOODSERVICE DIVISION**

2001 East Terra Lane • O'Fallon, Missouri 63366-4434 • (636)240-2400  
 Fax (636)272-2408 • Toll Free (800)325-6152 • Intl Fax# (001)636-272-7546  
 Parts Dept. (800)424-TRUE • Parts Dept. Fax# (636)272-9471 • www.truemfg.com

Project Name: \_\_\_\_\_

Location: \_\_\_\_\_

Item #: \_\_\_\_\_ Qty: \_\_\_\_\_

Model #: \_\_\_\_\_

A/A #

S/S #

Model:  
**GDM-26-HC~TSL01**

**Glass Door Merchandiser:**

*Swing Door Refrigerator with Hydrocarbon Refrigerant~True Standard Look Version 01*





**GDM-26-HC~TSL01**

- ▶ The world's #1 manufacturer of glass door merchandisers.
- ▶ Factory engineered, self-contained, capillary tube system using environmentally friendly R290 hydrocarbon refrigerant that has zero (0) ozone depletion potential (ODP), & three (3) global warming potential (GWP).
- ▶ Energy efficient, factory balanced, refrigeration system holds 33°F to 38°F (.5°C to 3.3°C).
- ▶ Exterior - non-peel or chip black powder coated cold rolled steel; durable and permanent.
- ▶ Interior - attractive, NSF approved, white aluminum interior liner with stainless steel floor.
- ▶ Self closing door. Positive seal, torsion type closure system.
- ▶ "Low-E", double pane thermal insulated glass door assembly with extruded aluminum frame. The latest in energy efficient technology.
- ▶ LED interior lighting provides more even lighting throughout the cabinet. Safety shielded.
- ▶ Entire cabinet structure is foamed-in-place using a high density, polyurethane insulation that has zero ozone depletion potential (ODP) and zero global warming potential (GWP).

**Bottom mounted units feature**

- ▶ "No stoop" lower shelf to maximize product visibility.
- ▶ Storage on top of cabinet.
- ▶ Easily accessible condenser coil for cleaning.

**Exterior Color Options**





		
Standard Black Exterior	Optional White Exterior	Optional Stainless Exterior

**ROUGH-IN DATA**

Specifications subject to change without notice.  
 Chart dimensions rounded up to the nearest 1/8" (millimeters rounded up to next whole number).

Model	Doors	Shelves	Cabinet Dimensions (inches) (mm)			HP	Voltage	Amps	NEMA Config.	Cord Length (total ft.) (total m)	Crated Weight (lbs.) (kg)
			W	D†	H						
GDM-26-HC~TSL01	1	5	30 762	29 7/8 759	78 5/8 1998	1/3 N/A	115/60/1	5.4 N/A	5-15P	9 2.74	325 148

† Depth does not include 1 1/8" (42 mm) for door handles.

    	<b>APPROVALS:</b>	<b>AVAILABLE AT:</b>
9/18	Printed in U.S.A.	

Model:  
GDM-26-HC~TSL01

# Glass Door Merchandiser: Swing Door Refrigerator with Hydrocarbon Refrigerant~True Standard Look Version 01



## STANDARD FEATURES

### DESIGN

- True's commitment to using the highest quality materials and oversized refrigeration systems provides the user with colder product temperatures, and lower utility costs in an attractive merchandiser that brilliantly displays packaged food and beverages.

### REFRIGERATION SYSTEM

- Factory engineered, self-contained, capillary tube system using environmentally friendly R290 hydrocarbon refrigerant that has zero (0) ozone depletion potential (ODP), & three (3) global warming potential (GWP).
- High capacity, factory balanced refrigeration system that maintains cabinet temperatures of 33°F to 38°F (.5°C to 3.3°C) for the best in food preservation.
- State of the art, electronically commutated evaporator and condenser fan motors. ECM motors operate at higher peak efficiencies and move a more consistent volume of air which produces less heat, reduces energy consumption and provides greater motor reliability.
- Bottom mounted condensing unit positioned for easy maintenance. "No stoop" lower shelf maximizes visibility by raising merchandised product to higher level.

### CABINET CONSTRUCTION

- Exterior - non-peel or chip black powder coated cold rolled steel; durable and permanent.
- Interior - attractive, NSF approved, white aluminum liner with stainless steel floor.

- Insulation - entire cabinet structure is foamed-in-place using a high density, polyurethane insulation that has zero ozone depletion potential (ODP) and zero global warming potential (GWP).
- Welded, heavy duty steel frame rail, black powder coated for corrosion protection.
- Frame rail fitted with leg levelers.
- Illuminated exterior sign panel. Variety of sign options available.

### DOOR

- "Low-E", double pane thermal insulated glass door assembly with extruded aluminum frame. The latest in energy efficient technology.
- Door fitted with 12" (305 mm) long integrated handle.
- Self closing door. Positive seal, torsion type closure system.
- Magnetic door gasket of one piece construction, removable without tools for ease of cleaning.

### SHELVING

- Five (5) adjustable, heavy duty PVC coated wire shelves 25 1/16" L x 23 1/4" D (653 mm x 591 mm). Four (4) chrome plated shelf clips included per shelf.
- Shelf support pilasters made of same material as cabinet interior; shelves are adjustable on 1/2" (13 mm) increments.

### LIGHTING

- LED interior lighting provides more even lighting throughout the cabinet. Safety shielded.

### MODEL FEATURES

- Evaporator is epoxy coated to eliminate the potential of corrosion.

- See our website [www.truefmg.com](http://www.truefmg.com) for latest color and sign offerings.
- Convenient clean-out drain built in cabinet floor.
- Listed under NSF/ANSI Standard 7 for the storage and/or display of packaged or bottled product.

### ELECTRICAL

- Unit completely pre-wired at factory and ready for final connection to a 115/60/1 phase, 15 amp dedicated outlet. Cord and plug set included.



115/60/1  
NEMA-5-15R

### OPTIONAL FEATURES/ACCESSORIES

Upcharge and lead times may apply.

- White exterior.
- Stainless steel exterior.
- Black aluminum interior liner with black shelving.
- Stainless steel interior liner.
- 6" (153 mm) standard legs.
- 6" (153 mm) seismic/flanged legs.
- 2 1/2" (64 mm) diameter castors.
- 4" (102 mm) diameter castors.
- Red wine thermostat.
- White wine thermostat.
- Chocolate thermostat.
- Barrel Locks – located in grill assembly (requires one per door)
- Additional shelves.
- TrueFlex gravity feed organizers.
- Pricing strips.

## PLAN VIEW

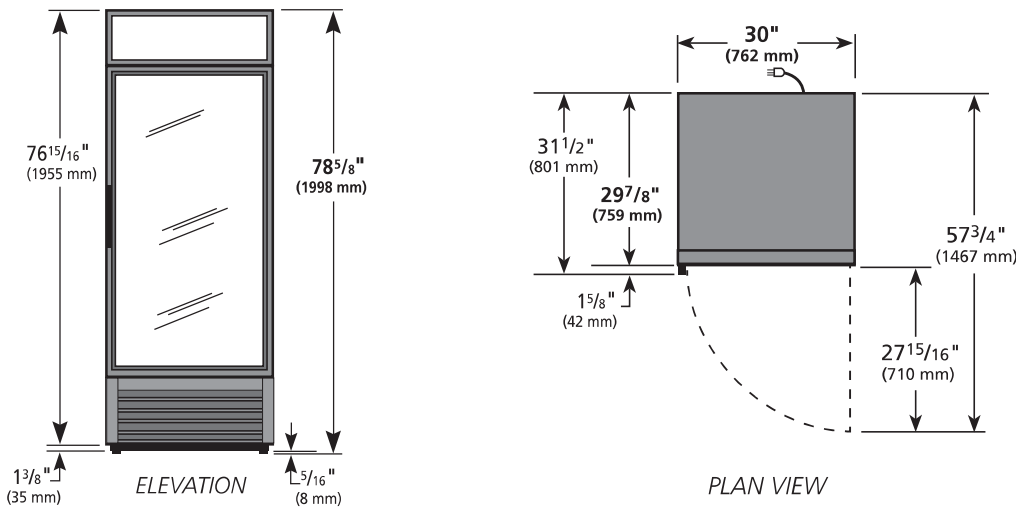

### WARRANTY

Three year warranty on all parts and labor and an additional 2 year warranty on compressor. (U.S.A. only)

METRIC DIMENSIONS ROUNDED UP TO THE NEAREST WHOLE MILLIMETER

SPECIFICATIONS SUBJECT TO CHANGE WITHOUT NOTICE



Model	Elevation	Right	Plan	3D	Back
GDM-26-HC~TSL01					

## TRUE MANUFACTURING CO., INC.

2001 East Terra Lane • O'Fallon, Missouri 63366-4434 • (636)240-2400 • Fax (636)272-2408 • Toll Free (800)325-6152 • Intl. Fax# (001)636-272-7546 • [www.truefmg.com](http://www.truefmg.com)